



PLEASE DO NOT RETURN THIS
PRODUCT TO THE STORE

*If you find that you have any trouble or missing or damaged parts
please contact us.*

*If you need installation assistance, replacement parts or have
questions regarding our warranty, please contact our product
consultants at info@regentproducts.mx or call toll free:*

800-847-7264

Monday to Friday from 8:30 a.m. to 6:30 p.m., CST. English and Spanish spoken.
International Regions: Please contact your local distributor.

TEWEST
BATH COLLECTION

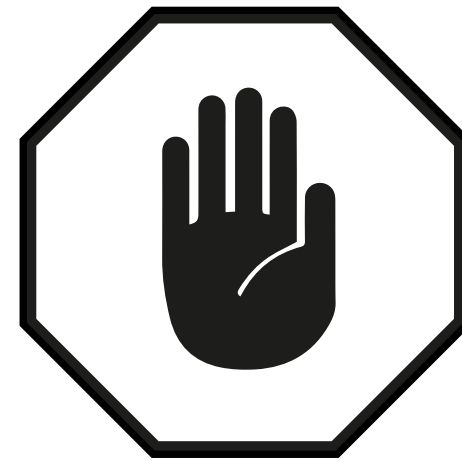

POR FAVOR NO DEVUELVA
ESTE PRODUCTO A LA TIENDA

*Si encuentra algún problema como partes faltantes o dañadas comuníquese
con nosotros.*

*Si necesita asistencia para la instalación, piezas de repuesto o tiene preguntas
relacionadas con la garantía, por favor contacte a nuestros consultores de
productos en info@regentproducts.mx o llame al número gratuito:*

800-847-7264

De lunes a viernes de 8:30 a.m. a 6:30 p.m., CST. Se habla Inglés y Español.
Otros países: Por favor contacte a su distribuidor local.

TEWEST
BATH COLLECTION



RFC: EMA1504167C6
Regent Products S. de R.L. de C.V
Ave. Jose Vasconcelos 638, Piso 3
Col. Valle del Campestre
San Pedro Garza Garcia, NL
C.P. 66265, MÉXICO

GARANTÍA

Los productos de 15WEST son fabricados bajo los más altos estándares de calidad y mano de obra. 15WEST garantiza al comprador original que este producto estará libre de defectos de fabricación, materiales y acabados por un período de un año a partir de la fecha de compra indicada en la factura. 15WEST recomienda instalación profesional para este producto.

Si este producto presentara alguna fuga o gotera derivada de un defecto de fabricación o de sus materiales, durante el período de garantía, 15WEST proporcionará sin costo alguno las piezas necesarias para su reparación. 15WEST también reemplazará cualquier pieza que tuviese un defecto en su acabado o en su proceso de fabricación. Esta garantía será válida sólo bajo condiciones normales de instalación, uso y servicio.

Esta garantía no aplica a los daños causados por el desgaste natural del producto, la instalación u operación incorrecta, las modificaciones realizadas por terceros no autorizados por 15WEST o el uso de piezas de repuesto de cualquier marca que no sea 15WEST. Esta garantía también excluye los daños causados por el uso de limpiadores abrasivos, que contienen alcohol u otros disolventes orgánicos; Si el daño fue causado por el consumidor o por terceros, 15WEST no será responsable por los gastos de mano de obra, los daños incurridos durante la instalación, la reparación o el reemplazo, ni por cualquier daño o pérdida directa, indirecta o consecuente relacionada con este producto. Esta garantía es responsabilidad exclusiva de 15WEST, no deja ningún derecho o acción adicional al comprador original o a terceros y libera a Regent Products S. de R.L. de C.V y cualquier otra subsidiaria, afiliada, accionista, distribuidor, minoristas, representantes, agentes y empleados de estos o de cualquier otra responsabilidad por defectos visibles o ocultos o daños de cualquier tipo.

La compra, posesión o uso del producto implica la aceptación por parte del comprador original de los términos y condiciones previstos en la presente garantía.

Para que el comprador original pueda hacer efectiva la garantía, cualquier reclamación deberá ir acompañada por el comprobante de compra (original). Para hacer válida esta garantía escriba a 15WEST al correo electrónico que se indica a continuación, con asunto: "15WEST Garantía". Explique el tipo de defecto e incluya el comprobante de compra, su nombre, dirección, código postal y número de teléfono. De ser procedente la reclamación, la(s) refacciones serán enviadas por correo a la dirección indicada sin costo alguno para el cliente.

info@regentproducts.mx
800-847-7264
lunes a viernes de 8:30 am a 6:30 pm



RFC: EMA1504167C6
Regent Products S. de R.L. de C.V
Ave. Jose Vasconcelos 638, Piso 3
Col. Valle del Campestre
San Pedro Garza Garcia, NL
C.P. 66265, MÉXICO

WARRANTY

15WEST products are manufactured under the highest quality and workmanship standards. 15WEST guarantees the original buyer that this product will be free of fabrication, material and finish defects for one year period starting at the purchase date. 15WEST recommends professional installation for this product.

Should this product present any leaks derived from a fabrication or material defect during the warranty period, 15WEST will supply the necessary replacement parts free of charge. 15WEST will also replace any pieces presenting defects in finish or fabrication. This warranty is only valid under normal installation, use and service conditions.

This warranty does not apply to any damage caused by normal wearing of the product, incorrect installation or operation, alterations or modifications performed by parties not authorized by 15WEST, or the use of replacement parts any brand other than 15WEST. This warranty also excludes damages caused by the use of abrasive cleaners, containing alcohol or other organic solvents; whether the damage was caused by the consumer or third parties. 15WEST will not be responsible for workmanship expenses, damages incurred during the installation, repair or replacement, or for any direct, indirect, consequent damage or losses related to this product. This warranty being 15WEST sole responsibility, leaving no further right or actions to the original buyer or third parties and liberating Regent Products S. de R.L. de C.V and any other subsidiaries, affiliates, shareholders, distributors, retailers, representatives, agents and employees of these or any other responsibility for visible or hidden defects or damages of any kind.

The purchase, use and ownership of this product implies acceptance on behalf of the original buyer of the terms and conditions of this warranty.

In order for the original buyer to make this warranty valid any claim must be accompanied by an original purchase ticket. To make this warranty valid write 15WEST to the email below with subject: "15WEST Warranty". Explain the kind of defect and include the purchase ticket (original), your full name and address, and phone number. Should the claim be compliant with warranty limitations, all necessary replacement parts will be mailed at no cost to the customer.

info@regentproducts.mx
800-847-7264
Monday to Friday from 8:30 am to 6:30 pm

INSTALLATION

5 Installing the Top and Basin

Gently place the basin (A) onto the cabinet (B).

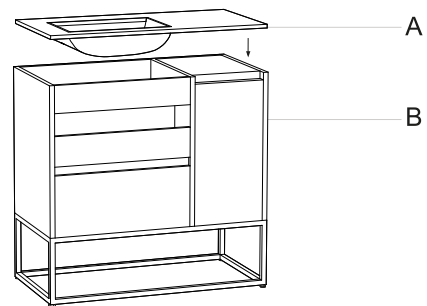

6 Installing the faucet & pop-up

Install the faucet (F,G,H,I,J) and drain (K,L,M,N,O,Q,P), as shown below.

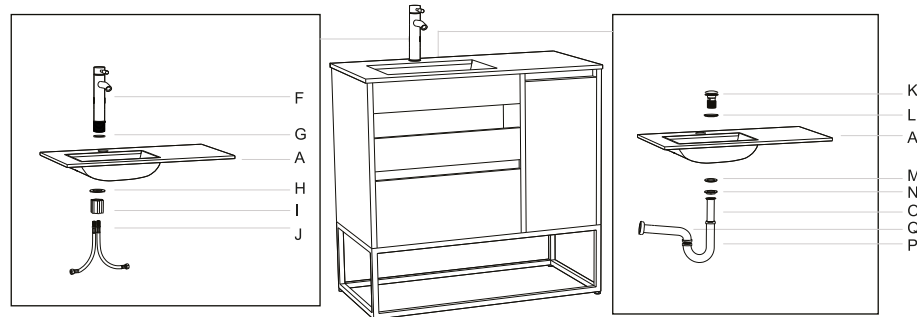

7 Installing the

Using three in one coupler (T,W,X) to install the shelf (E) to the mirror. Measure the distance between the mirror's hangers. Drill two leveled holes on the wall using this measurement. Insert anchors (R) into drilled holes and then screws (S) into anchors leaving 6-8mm of the screws exposed. Install mirror (as shown in figure). Measure the distance between the holes at the back of the side cabinet. Drill two leveled holes on the wall using the measurement. Insert anchors (R) into drilled holes and then install the side cabinet by using the screws (V,S), then

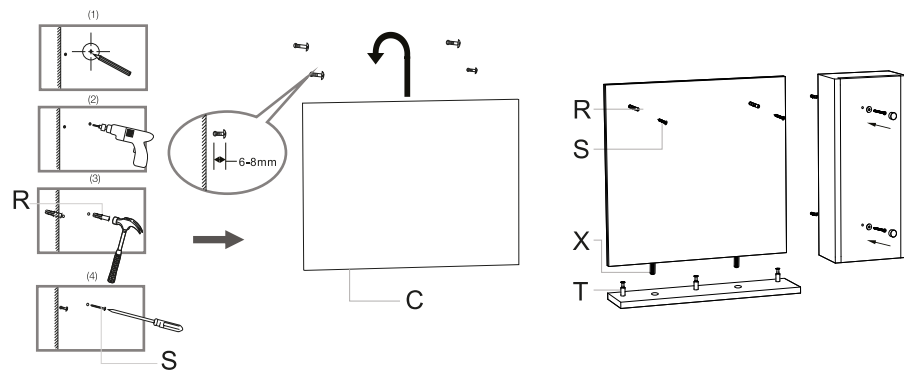

15WEST
BATH COLLECTION

EV975M-GRY
DORIS

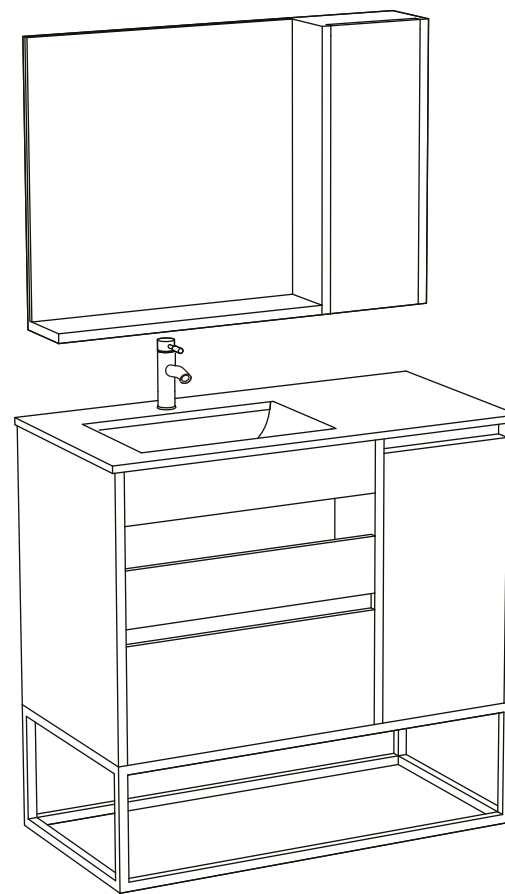

JUEGO DE GABINETE DE DOBLE MONTAJE



























Agradecemos la confianza que ha tenido en 15WEST a través de la compra de este gabinete para baño. Nos esforzamos para continuamente crear productos de calidad diseñados para mejorar su hogar. Visítenos por Internet para ver nuestra línea completa de productos disponibles para las necesidades de mejorar su hogar. ¡Gracias por elegir 15WEST!

04OCT21







Tiempo Estimado de Instalación
24 horas son necesarias para completar el proceso de instalación.

Número de Personas Requeridas
Dos personas son recomendadas para completar el proceso de instalación.

LISTA DE PIEZAS

 A (1PC)	 B (1PC)	 C (1PC)	 D (1PC)	 E (1PC)	 F (1PC)	 G (1PC)	 H (1PC)		
 I (1PC)	 J (2PC)	 K (1PC)	 L (1PC)	 M (1PC)	 N (1PC)	 O (1PC)	 P (1PC)		
 Q (1PC)	 R (10PC)	 S (10PC)	 T (3PC)	 U (2PC)	 V (2PC)	 W (3PC)	 X (2PC)	 Y (2PC)	 Z (2PC)

HERRAMIENTAS REQUERIDAS (NO INCLUIDAS)

 Destornillador Phillips	 Taladro eléctrico	 Mazo suave	 Sellador	 Lápiz	 Nivelador	 Cinta métrica
--	--	---	---	--	---	--

CONTENIDO DEL PAQUETE

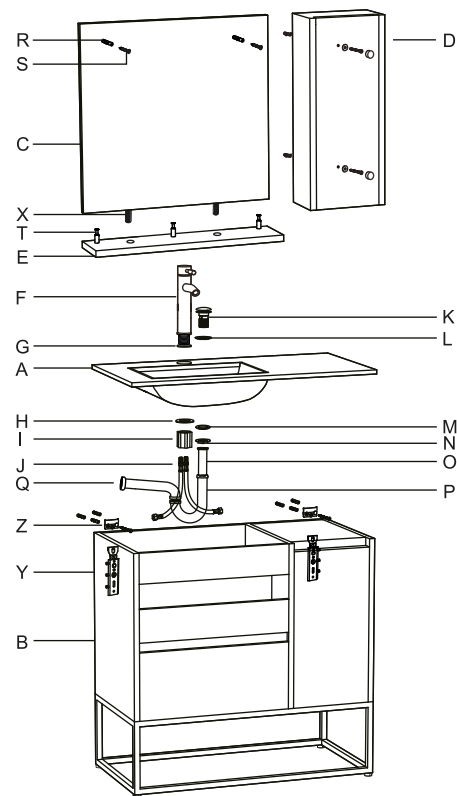

INSTALLATION

1 Optional: Remove the Legs

Remove the attached legs by removing the screws located at the bottom of the legs and cabinet (B).

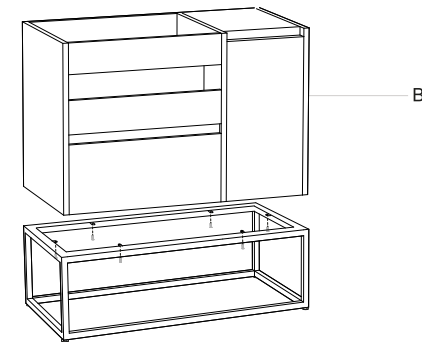

2 Wall Mounting Installation

Measure the holes on the vanity wall bracket (Z). Drill six leveled holes (8mm) on the wall using this measurement. Insert anchors (R) into drilled holes (8mm).

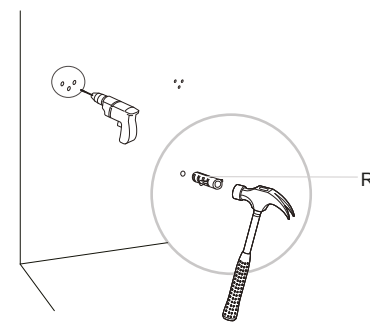

3 Wall Mounting Installation

Insert the metal stud screws (S) through the vanity wall brackets (Z). Secure and tighten with drill.

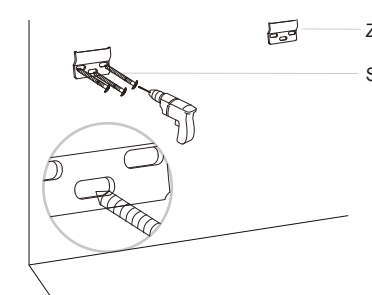

4 Wall Mounting Installation



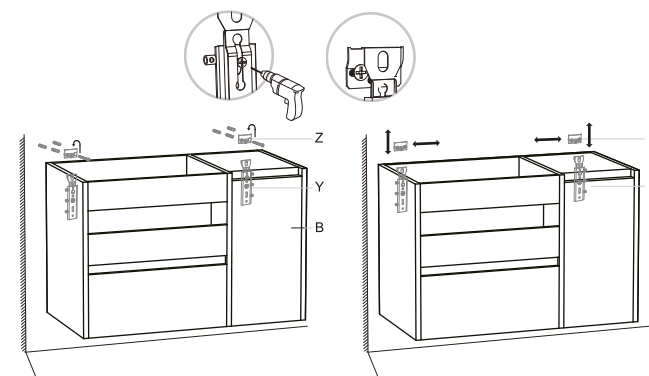























Lift the vanity (B) and place the bracket (Y) over on the wall bracket (Z), secure the screw on the bracket (Y) to make sure the vanity is installed tightly.









Estimated Installation Time
Twenty-four hours are needed to complete the installation process.

Number of People Required
Two people are recommended to complete the installation process.

PARTS LIST

TOOLS REQUIRED (NOT INCLUDED)

						
---	---	---	---	---	--	---

PACKAGE CONTENTS

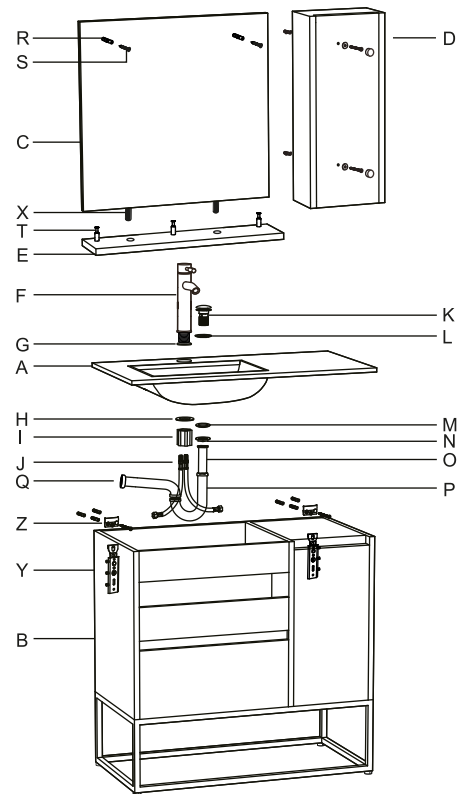

INSTALACIÓN

1 Opcional: Quitar las Patas

Retire las patas fijadas quitando los tornillos situados en la parte inferior de las patas y el gabinete (B).

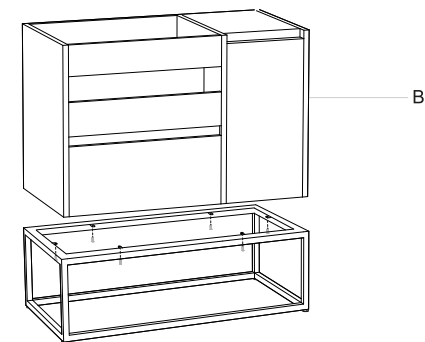

2 Instalación Montaje de Pared

Mida los agujeros en el soporte de pared del gabinete (Z). Taladre seis agujeros nivelados (8mm) en la pared con esta medida. Inserte los taquetes (R) en los agujeros (8mm).

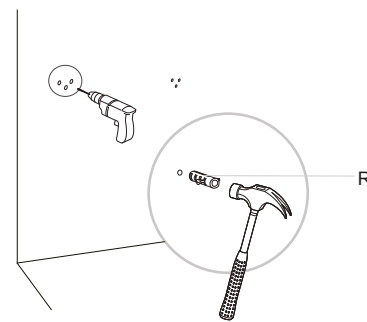

3 Instalación Montaje de Pared

Inserte los tornillos de viga metal (S) a través de los soportes de pared del gabinete (Z). Asegure y ajuste con el taladro.

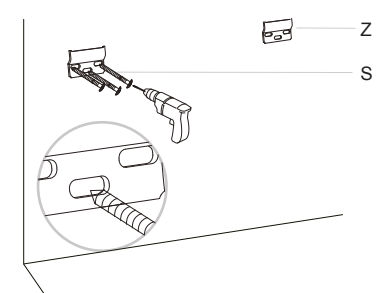

4 Instalación Montaje de Pared

Levante el tocador (B) y coloque el soporte (Y) sobre el soporte de pared (Z), asegure el tornillo en el soporte (Y) para asegurarse de que el tocador esté bien instalado.

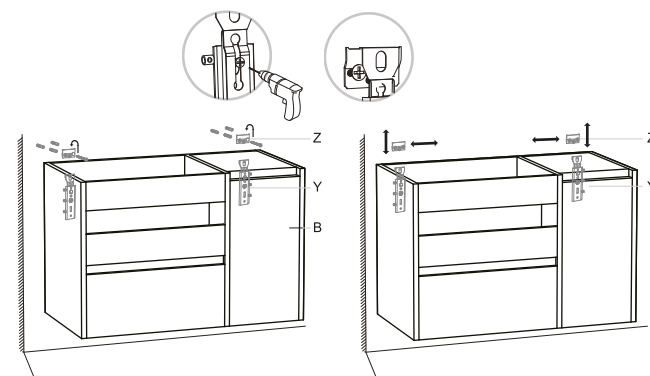

INSTALACIÓN

5 Instalación de la Cubierta y

Coloque con cuidado el recipiente (A) sobre el armario (B).

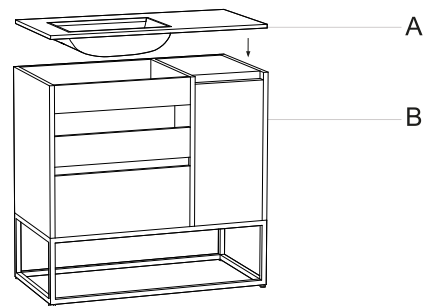

6 Instalación de la mezcladora y

Instale el mezcladora (F, G, H, I, J) y el desagüe (K, L, M, N, O, Q, P), como se muestra a

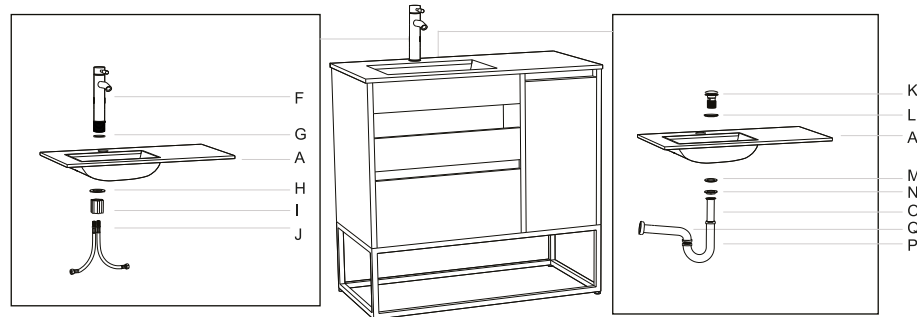

7 Instalación del

Usando tres en un acoplador (T, W, X) para instalar el estante (E) en el espejo. Mide la distancia entre las perchas del espejo. Perfore dos orificios nivelados en la pared utilizando esta medición. Inserte anclajes (R) en orificios perforados y luego atornille (S) en anclajes dejando 6-8 mm de los tornillos expuestos. Instale el espejo (como se muestra en la figura). Asegure la distancia entre los orificios en la parte posterior del gabinete lateral. Perfore dos orificios nivelados en la pared utilizando la medición. Inserte los anclajes (R) en los orificios perforados y luego instale el gabinete lateral usando los tornillos (V, S), luego coloque la tapa de la cubierta (U).

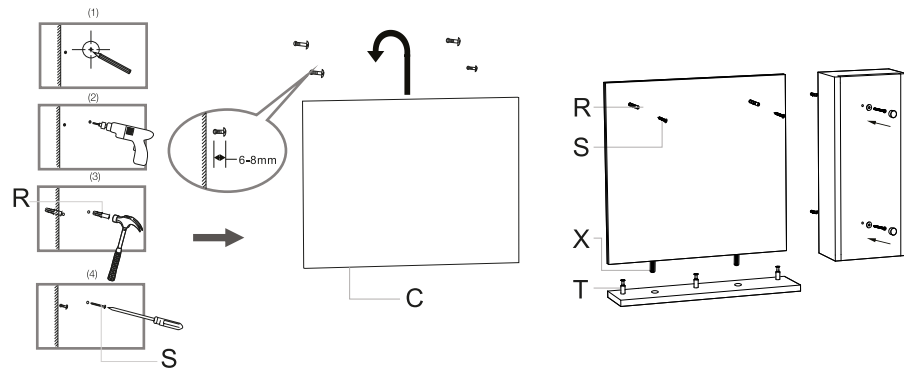

15WEST
BATH COLLECTION

EV975M-GRY
DORIS

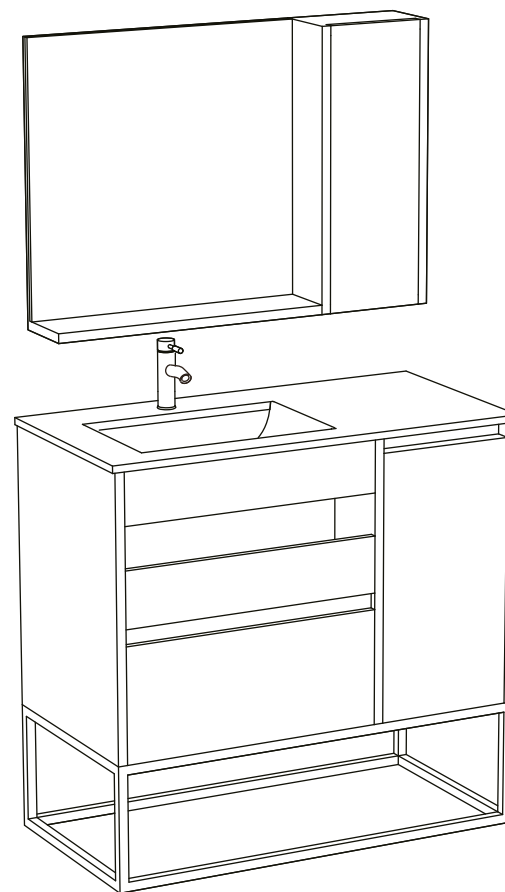

DUAL MOUNT VANITY SET

We appreciate the trust and confidence you have placed in 15WEST through the purchase of this bathroom vanity. We strive to continually create quality products designed to enhance your home. Visit us online to see our full line of products available for your home improvement needs. Thank you for choosing 15WEST!

04OCT21