

# TEWEST

## BATH COLLECTION



### Tiempo Estimado de Instalación

#### Estimated Installation Time

Son necesarias 24 horas para completar el proceso de instalación.  
Twenty-four hours is needed to complete the installation process.











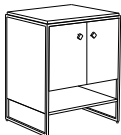

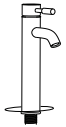

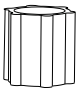
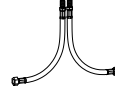

### Número de Personas Requeridas





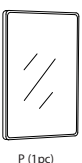

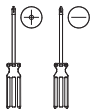

#### Number of People Required

Dos personas son recomendadas para completar el proceso de instalación.  
Two people are recommended to complete the installation process.

### LISTA DE PIEZAS - PARTS LIST

 A (1pc)	 B (1pc)	 C (1pc)	 D (1pc)	 E (1pc)	 F (1pc)	 G (1pc)	 H (1pc)	 I (1pc)
 J (1pc)	 K (1pc)	 L (1pc)	 M (1pc)	 N (1pc)	 O (1pc)	 P (1pc)	 Q (2pc)	 R (2pc)

### HERRAMIENTAS REQUERIDAS (NO INCLUIDAS) / TOOLS REQUIRED (NOT INCLUDED)

 Destornillador Phillips Phillips screwdriver	 Taladro eléctrico Electric drill	 Mazo suave Soft mallet	 Sellador Sealant	 Lápiz Pencil	 Nivelador Level	 Cinta métrica Measuring tape	 Martillo Hammer
--	--	--	--	--	---	--	---

### CONTENIDO DEL PAQUETE / PACKAGE CONTENTS

### INSTALACIÓN / INSTALLATION

#### 1 Instalación de la placa y lavabo Installing the top & basin

Según las recomendaciones del fabricante, aplique sellador al borde superior del gabinete, no aplique demasiado. Coloque con cuidado la placa (B) sobre el gabinete (A). Luego aplique sellador al borde superior trasera de la placa (B) y de la pared. Deje secar durante 24 horas para una curación apropiada. Aplique sellador debajo del lavabo (C), no aplique demasiado. Coloque con cuidado el lavabo (C) sobre la placa (B). Deje secar durante 24 horas para una curación apropiada.

According to the sealant manufacturer's recommendations, apply sealant to the top edges of the cabinet, do not over apply. Gently place the countertop (B) onto the cabinet (A). Then apply sealant to the top back edge of the top (B) and wall. Allow to dry for 24 hours for proper curing.

Apply sealant to the bottom of the basin (C), do not over apply. Gently place the basin (C) onto the countertop (B). Allow to dry for 24 hours for proper curing. Gently place the basin (C) onto the countertop (B) and then the cabinet (A). Allow to dry for twenty-four hours for proper curing.

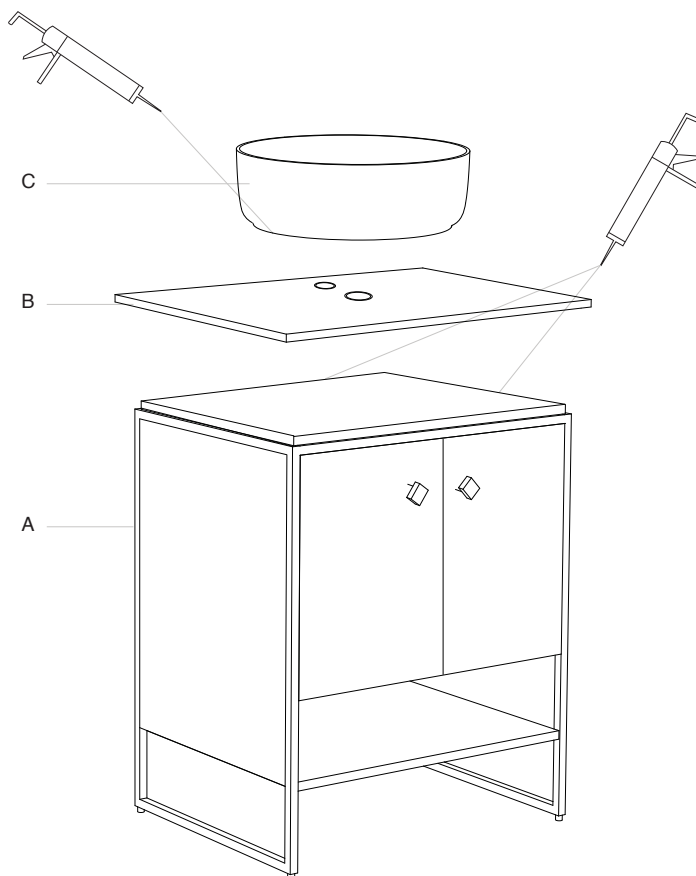
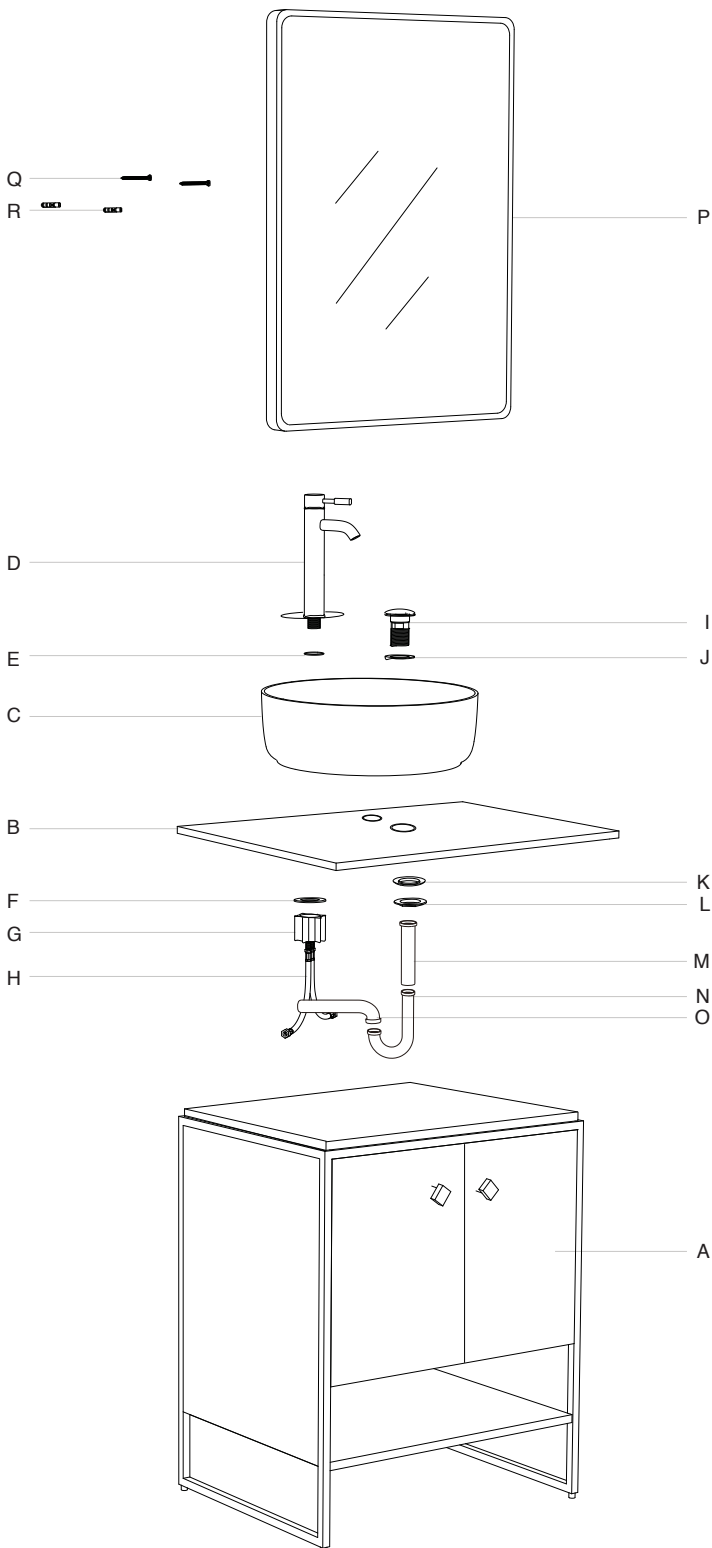

## INSTALACIÓN / INSTALLATION

### 3 Instalación del desagüe y céspol Installing the pop-up and drain

Coloque el desagüe (I) con la arandela (J) en el agujero del lavabo (C) y la placa (B). Asegure el desagüe (I) con la arandela y tuerca (K,L). Luego instale el céspol (M,N,O).

Place the pop-up (I) with washer (J) into the hole of the basin (C) and countertop (B). Secure the pop-up (I) with washer and nut (K,L). Then install the drain (M,N,O).

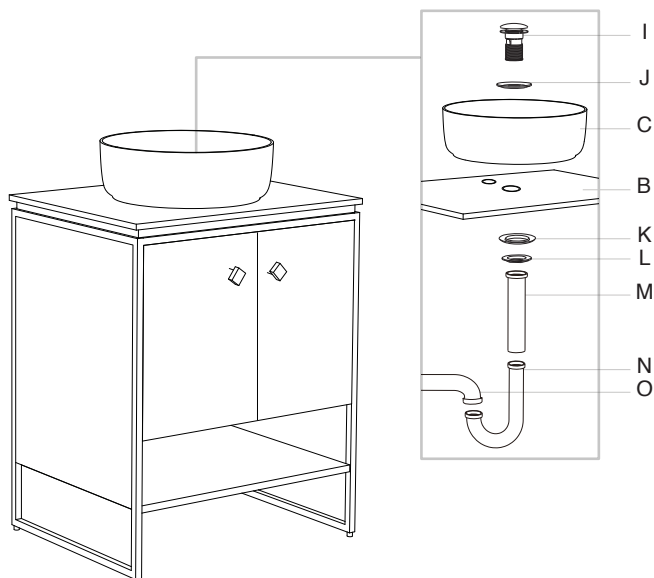

### 4 Instalación de la mezcladora Installing the faucet

Aplique la masilla de plomería según las recomendaciones del fabricante. Apriete a mano las mangueras (H) en los orificios situados en la parte inferior de la mezcladora (D). Inserte las mangueras por la arandela de goma (E) y el orificio la placa (B). Enrosque la arandela de goma (F) y la tuerca (G) sobre las mangueras y vástago desde abajo del lavabo. Apriete la tuerca.

Apply plumber's putty according to manufacturer's recommendations. Hand-tighten hoses (H) in holes at the bottom of faucet (D). Insert hoses through the rubber washer (E) and the countertop (B) hole. Thread rubber washer (F) and nut (G) onto hoses and shank from below basin. Tighten nut.

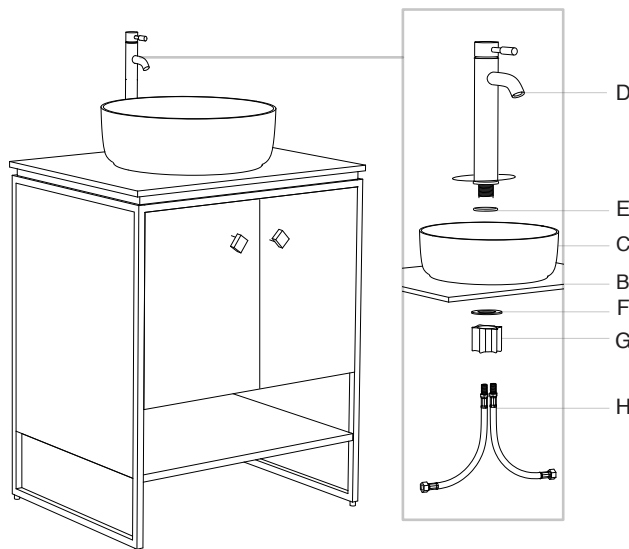

### 5 Instalación del espejo Installing the mirror

Decida la dirección del espejo: Vertical u Horizontal.

Mida la distancia entre los soportes del espejo. Taladre dos agujeros nivelados en la pared con esta medida. Inserte los taquetes (R) en los agujeros taladrados, luego inserte los tornillos (Q) en los taquetes, dejando expuesto 6-8mm de los tornillos. Instale el espejo (P) (como se muestra en la figura).

Decide the direction of the mirror: Vertical or Horizontal.

Measure the distance between the mirror's hangers. Drill two leveled holes on the wall using the measurement. Insert anchors (R) into drilled holes and then screws (Q) into anchors leaving 6-8mm of the screws exposed. Install mirror (P) (as shown in the figure).

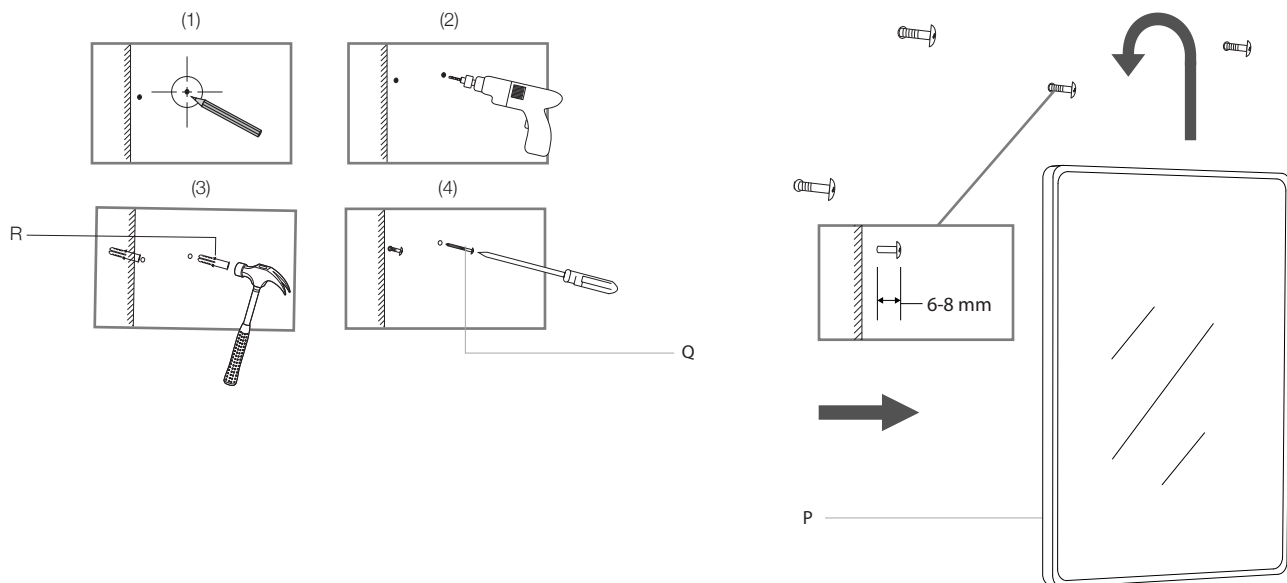

## Mantenimiento / Maintenance

Compruebe las conexiones de apoyo y soportes por lo menos dos veces al año para asegurarse de que estén fijas. Por el uso constante, algunas conexiones pueden aflojarse con el tiempo.

Check the support connections and brackets at least twice a year to make sure they are secure. Due to constant use, some connections may become loose over time.

## Limpeza / Care and Cleaning

- Para limpiar el gabinete, utilice un paño suave y seco.
- No exponga el gabinete prolongadamente a luz directa del sol.
- No permita que ningún objeto afilado raye el gabinete.
- No permita que el gabinete entre en contacto con fuentes de calor alto.
- Limpie inmediatamente cualquier derrame y líquidos.
- No utilice limpiadores con productos químicos, disolventes o abrasivos.

- To clean the fixture, wipe with a soft, dry cloth.
- Do not expose the vanity to direct prolonged sunlight.
- Do not let any sharp objects scratch the vanity.
- Do not let the fixture come in contact with high heat sources.
- Wipe down any spills and liquids immediately.
- Do not use any cleaners with chemicals, solvents, or harsh abrasives.

Agradecemos la confianza que ha tenido en 15WEST a través de la compra de este gabinete para baño. Nos esforzamos para continuamente crear productos de calidad diseñados para mejorar su hogar. Visítenos por Internet para ver nuestra línea completa de productos disponibles para las necesidades de mejora de su hogar. ¡Gracias por elegir 15WEST!

We appreciate the trust and confidence you have placed in 15WEST through the purchase of this bathroom vanity. We strive to continually create quality products designed to enhance your home. Visit us online to see our full line of products available for your home improvement needs. Thank you for choosing 15WEST!