



PLEASE DO NOT RETURN THIS
PRODUCT TO THE STORE

*If you find that you have any trouble or missing or damaged parts
please contact us.*

*If you need installation assistance, replacement parts or have
questions regarding our warranty, please contact our product
consultants at info@regentproducts.mx or call toll free:*

800-847-7264

Monday to Friday from 8:30 a.m. to 6:30 p.m., CST. English and Spanish spoken.
International Regions: Please contact your local distributor.

TEWEST
BATH COLLECTION

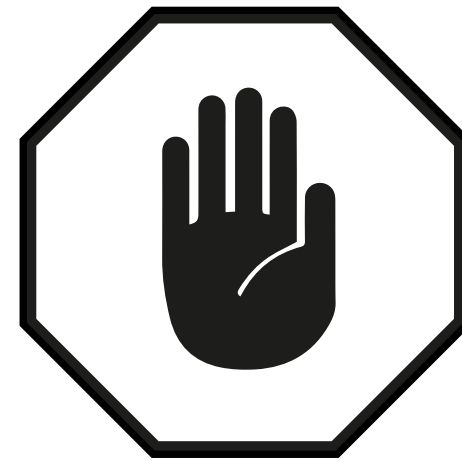

POR FAVOR NO DEVUELVA
ESTE PRODUCTO A LA TIENDA

*Si encuentra algún problema como partes faltantes o dañadas comuníquese
con nosotros.*

*Si necesita asistencia para la instalación, piezas de repuesto o tiene preguntas
relacionadas con la garantía, por favor contacte a nuestros consultores de
productos en info@regentproducts.mx o llame al número gratuito:*

800-847-7264

De lunes a viernes de 8:30 a.m. a 6:30 p.m., CST. Se habla Inglés y Español.
Otros países: Por favor contacte a su distribuidor local.

TEWEST
BATH COLLECTION



RFC: EMA1504167C6
Regent Products S. de R.L. de C.V
Ave. Jose Vasconcelos 638, Piso 3
Col. Valle del Campestre
San Pedro Garza Garcia, NL
C.P. 66265, MÉXICO

GARANTÍA

Los productos de 15WEST son fabricados bajo los más altos estándares de calidad y mano de obra. 15WEST garantiza al comprador original que este producto estará libre de defectos de fabricación, materiales y acabados por un período de un año a partir de la fecha de compra indicada en la factura. 15WEST recomienda instalación profesional para este producto.

Si este producto presentara alguna fuga o gotera derivada de un defecto de fabricación o de sus materiales, durante el período de garantía, 15WEST proporcionará sin costo alguno las piezas necesarias para su reparación. 15WEST también reemplazará cualquier pieza que tuviese un defecto en su acabado o en su proceso de fabricación. Esta garantía será válida sólo bajo condiciones normales de instalación, uso y servicio.

Esta garantía no aplica a los daños causados por el desgaste natural del producto, la instalación u operación incorrecta, las modificaciones realizadas por terceros no autorizados por 15WEST o el uso de piezas de repuesto de cualquier marca que no sea 15WEST. Esta garantía también excluye los daños causados por el uso de limpiadores abrasivos, que contienen alcohol u otros disolventes orgánicos; Si el daño fue causado por el consumidor o por terceros, 15WEST no será responsable por los gastos de mano de obra, los daños incurridos durante la instalación, la reparación o el reemplazo, ni por cualquier daño o pérdida directa, indirecta o consecuente relacionada con este producto. Esta garantía es responsabilidad exclusiva de 15WEST, no deja ningún derecho o acción adicional al comprador original o a terceros y libera a Regent Products S. de R.L. de C.V y cualquier otra subsidiaria, afiliada, accionista, distribuidor, minoristas, representantes, agentes y empleados de estos o de cualquier otra responsabilidad por defectos visibles o ocultos o daños de cualquier tipo.

La compra, posesión o uso del producto implica la aceptación por parte del comprador original de los términos y condiciones previstos en la presente garantía.

Para que el comprador original pueda hacer efectiva la garantía, cualquier reclamación deberá ir acompañada por el comprobante de compra (original). Para hacer válida esta garantía escriba a 15WEST al correo electrónico que se indica a continuación, con asunto: "15WEST Garantía". Explique el tipo de defecto e incluya el comprobante de compra, su nombre, dirección, código postal y número de teléfono. De ser procedente la reclamación, la(s) refacciones serán enviadas por correo a la dirección indicada sin costo alguno para el cliente.

info@regentproducts.mx
800-847-7264
lunes a viernes de 8:30 am a 6:30 pm



RFC: EMA1504167C6
Regent Products S. de R.L. de C.V
Ave. Jose Vasconcelos 638, Piso 3
Col. Valle del Campestre
San Pedro Garza Garcia, NL
C.P. 66265, MÉXICO

WARRANTY

15WEST products are manufactured under the highest quality and workmanship standards. 15WEST guarantees the original buyer that this product will be free of fabrication, material and finish defects for one year period starting at the purchase date. 15WEST recommends professional installation for this product.

Should this product present any leaks derived from a fabrication or material defect during the warranty period, 15WEST will supply the necessary replacement parts free of charge. 15WEST will also replace any pieces presenting defects in finish or fabrication. This warranty is only valid under normal installation, use and service conditions.

This warranty does not apply to any damage caused by normal wearing of the product, incorrect installation or operation, alterations or modifications performed by parties not authorized by 15WEST, or the use of replacement parts any brand other than 15WEST. This warranty also excludes damages caused by the use of abrasive cleaners, containing alcohol or other organic solvents; whether the damage was caused by the consumer or third parties. 15WEST will not be responsible for workmanship expenses, damages incurred during the installation, repair or replacement, or for any direct, indirect, consequent damage or losses related to this product. This warranty being 15WEST sole responsibility, leaving no further right or actions to the original buyer or third parties and liberating Regent Products S. de R.L. de C.V and any other subsidiaries, affiliates, shareholders, distributors, retailers, representatives, agents and employees of these or any other responsibility for visible or hidden defects or damages of any kind.

The purchase, use and ownership of this product implies acceptance on behalf of the original buyer of the terms and conditions of this warranty.

In order for the original buyer to make this warranty valid any claim must be accompanied by an original purchase ticket. To make this warranty valid write 15WEST to the email below with subject: "15WEST Warranty". Explain the kind of defect and include the purchase ticket (original), your full name and address, and phone number. Should the claim be compliant with warranty limitations, all necessary replacement parts will be mailed at no cost to the customer.

info@regentproducts.mx
800-847-7264
Monday to Friday from 8:30 am to 6:30 pm

INSTALLATION

3 Installing the basin

According to the sealant manufacturer's recommendations, apply sealant to the top edges of the cabinet, countertop, and basin. Do not over apply. Gently place the countertop (A1) onto the cabinet (B1) and gently place the basin (A2) onto the countertop(A1). Allow to dry for twenty-four hours for proper curing.



4 Installing the faucet

Install the pop-up (H,I), faucet (C,D,E,F,G), and drain (J,K,L,N,M) as shown below.

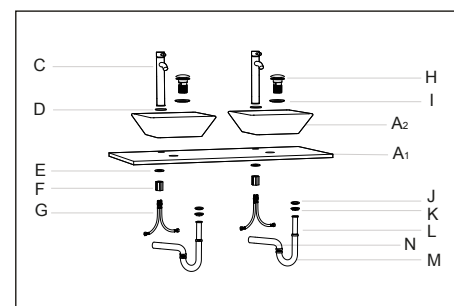
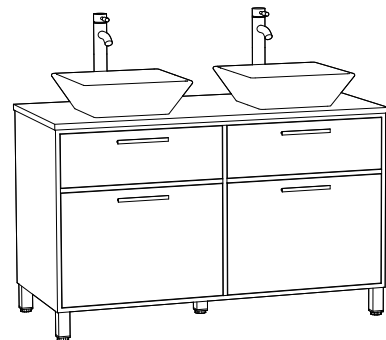

5 Installing the mirror

Measure the distance between the mirror's hangers. Drill two leveled holes on the wall using this measurement. Insert anchors (Q) into drilled holes and then screws (R) into anchors leaving 6-8mm of the screws exposed. Install mirror (as shown in figure).

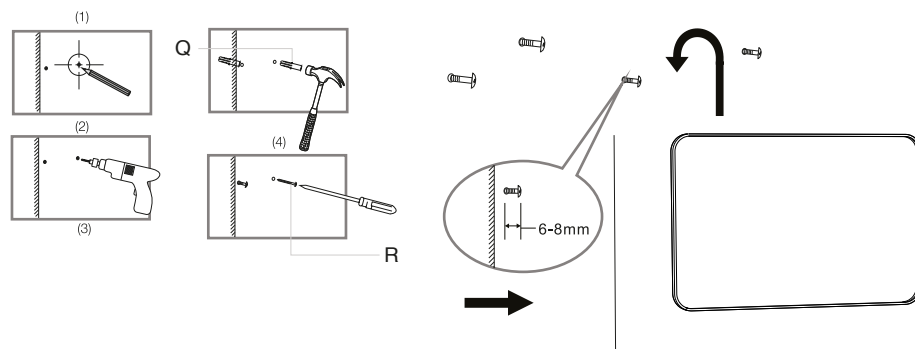

15WEST
BATH COLLECTION

EV8334M
SEDONA

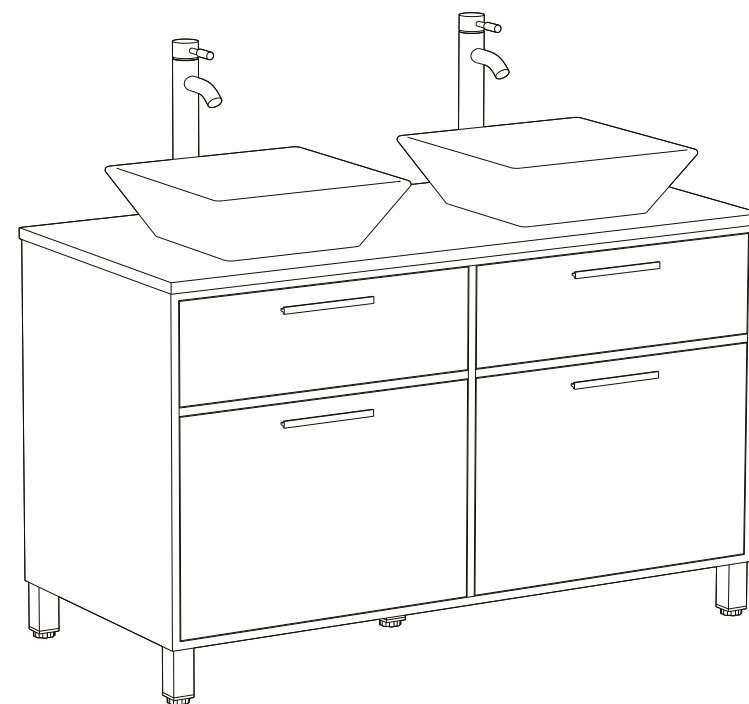

JUEGO DE GABINETE DE BAÑO























Agradecemos la confianza que ha tenido en 15WEST a través de la compra de este gabinete para baño. Nos esforzamos para continuamente crear productos de calidad diseñados para mejorar su hogar. Visítenos por Internet para ver nuestra línea completa de productos disponibles para las necesidades de mejorar su hogar. ¡Gracias por elegir 15WEST!

24MAY21







Tiempo Estimado de Instalación
24 horas son necesarias para completar el proceso de instalación.

Número de Personas Requeridas
Dos personas son recomendadas para completar el proceso de instalación.

LISTA DE PIEZAS

 A1 (1pc)	 A2 (2pc)	 B1 (1pc)	 B2 (1pc)	 B3 (4pc)	 C (2pc)	 D (2pc)	
 E (2pc)	 F (2pc)	 G (4pc)	 H (2pc)	 I (2pc)	 J (2pc)	 K (2pc)	 L (2pc)
 M (2pc)	 N (2pc)	 P (8pc)	 Q (2pc)	 R (2pc)	 S (5pc)	 T (15pc)	

HERRAMIENTAS REQUERIDAS (NO INCLUIDAS)

 Destornillador Phillips	 Taladro eléctrico	 Mazo suave	 Sellador	 Lápiz	 Nivelador	 Cinta métrica
--	--	---	---	--	--	--

CONTENIDO DEL

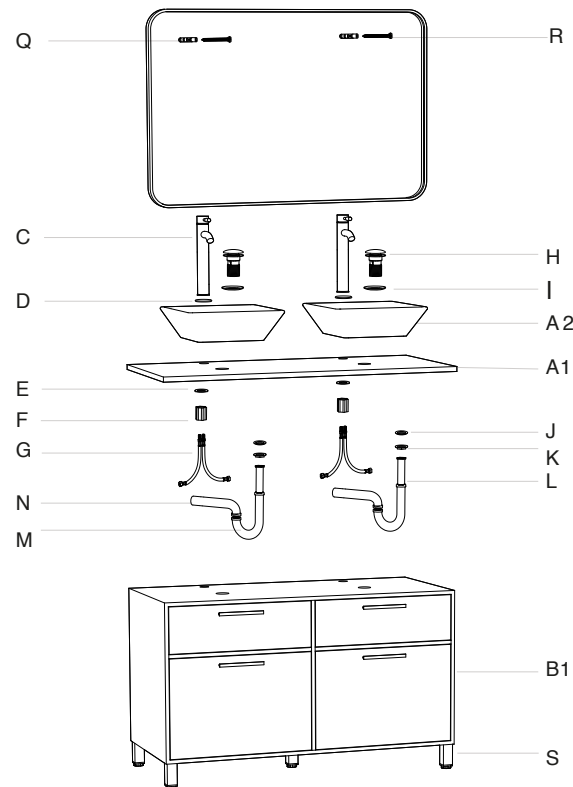

INSTALLATION

1 Installing the legs

Install legs (S) onto the bottom of the cabinet (B1) using the screws (T).

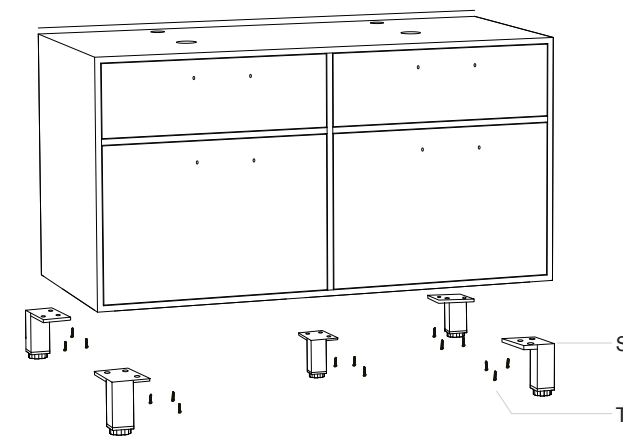

2 Installing the handle



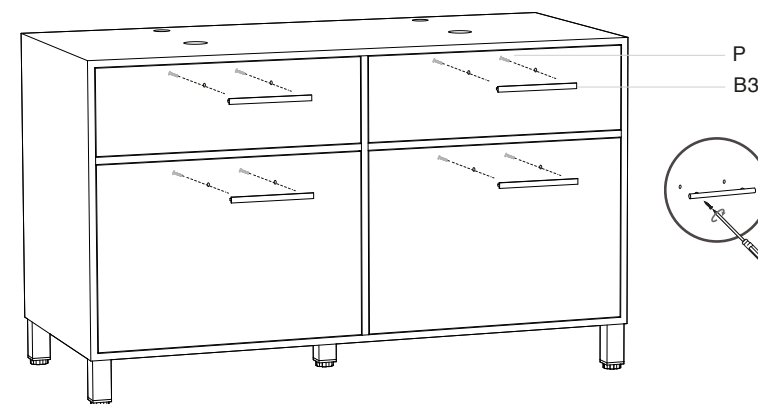



















For shipping purposes, the handle (B3) is pre-installed on the inside of the drawer. Un-install the handle (B3). Re-attach the handle (B3) onto the front of the cabinet's drawer using screws.









Estimated Installation Time
Twenty-four hours are needed to complete the installation process.

Number of People Required
Two people are recommended to complete the installation process.

PARTS LIST

 A1 (1pc)	 A2 (2pc)	 B1 (1pc)	 B2 (1pc)	 B3 (4pc)	 C (2pc)	 D (2pc)	
 E (2pc)	 F (2pc)	 G (4pc)	 H (2pc)	 I (2pc)	 J (2pc)	 K (2pc)	 L (2pc)
 M (2pc)	 N (2pc)	 P (8pc)	 Q (2pc)	 R (2pc)	 S (5pc)	 T (15pc)	

TOOLS REQUIRED (NOT)

 Phillips screwdriver	 Electric drill	 Soft mallet	 Sealant	 Pencil	 Level	 Measuring tape
---	---	--	--	---	--	---

PACKAGE CONTENTS

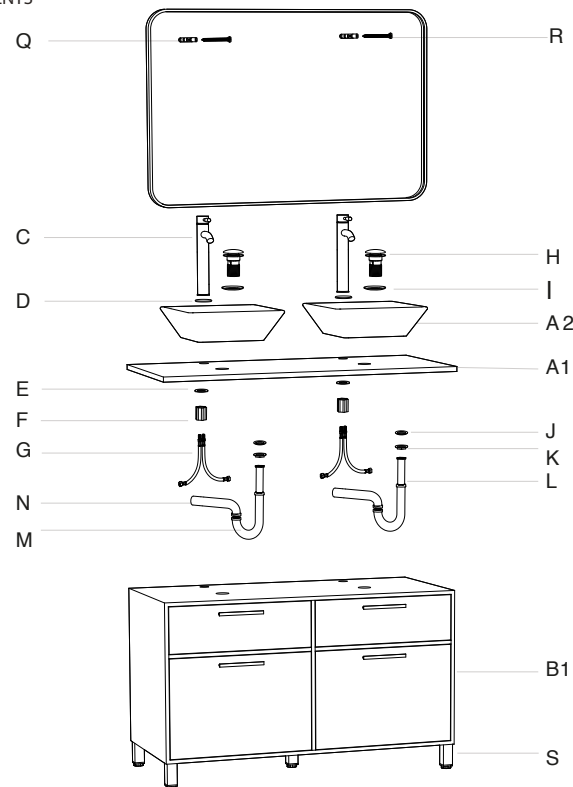

INSTALACIÓN

1 Instalación de las piernas

Instale las patas (S) en la parte inferior del armario (B1) utilizando los tornillos (T).

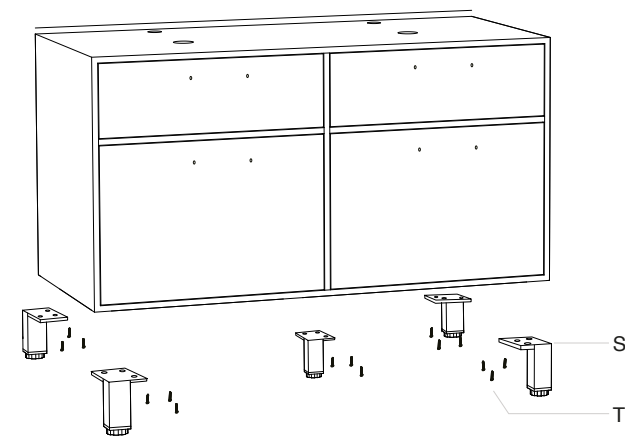

2 Instalación de la manija

Por motivos de envío, la manija (B3) está preinstalada en el interior del cajón. Desinstale la manija (B3). Vuelva a colocar la manija (B3) sobre el cajón del gabinete usando tornillos.

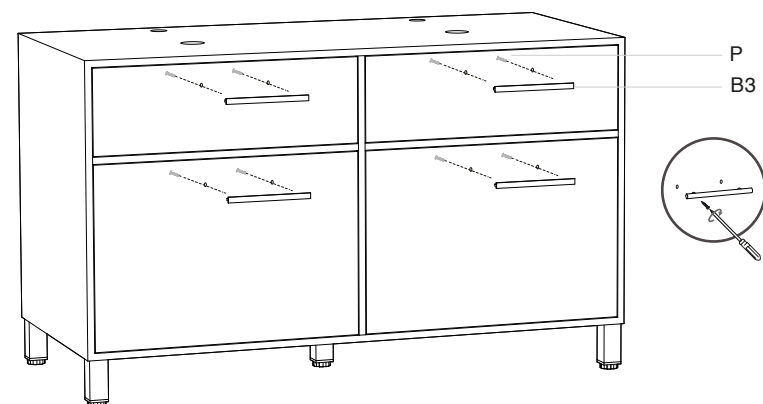

INSTALACIÓN

3 Instalación del gabinete

De acuerdo con las recomendaciones del fabricante del sellador, aplique sellador a los bordes superiores del armario, la encimera y la cubeta. No aplicar en exceso. Coloque suavemente la encimera (A1) sobre el armario (B1) y coloque suavemente el lavabo (A2) sobre la encimera (A1). Deje secar por veinticuatro horas para el curado



4 Instalación del grifo

Instale el elemento emergente (H,I), el grifo (C,D,E,F,G) y el drenaje (J,K,L,N,M) como se muestra a

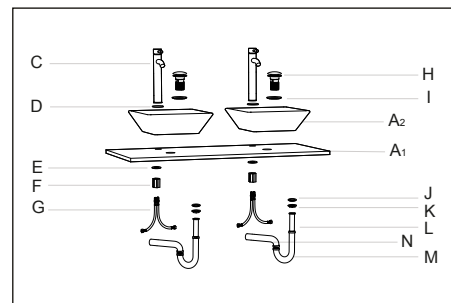
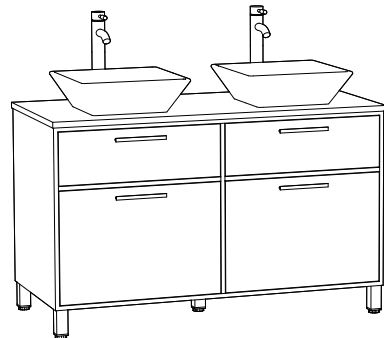

5 Instalación del espejo

Mida la distancia entre las perchas del espejo. Perfore dos orificios nivelados en la pared utilizando la medida.
 Inserte los anclajes (Q) en los orificios perforados y, a continuación, los tornillos (R) en los anclajes dejando 6-8mm de los tornillos expuestos.
 Instale el espejo (como se muestra en la figura).

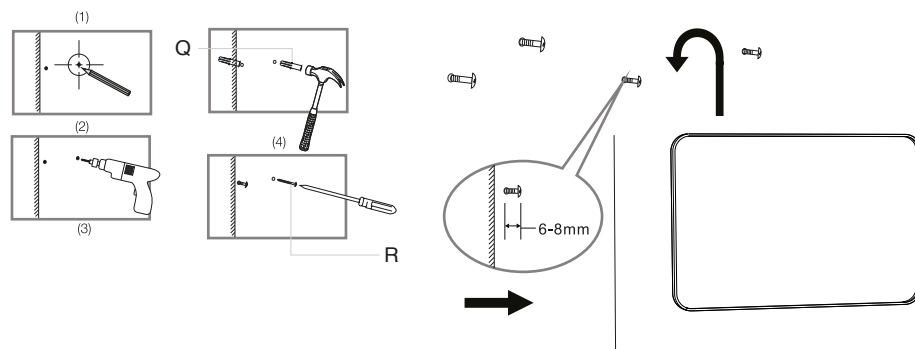

15WEST
BATH COLLECTION

EV8334M
SEDONA

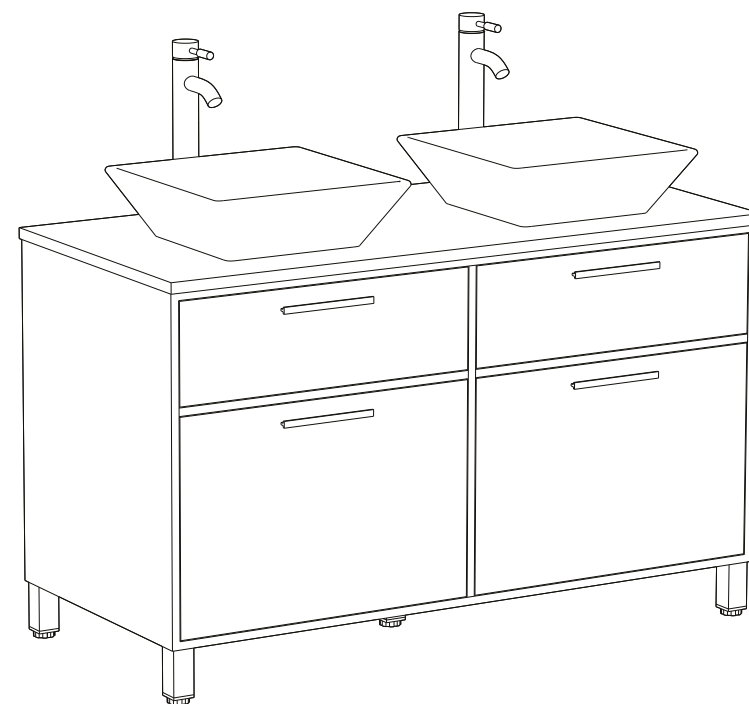

DOUBLE VANITY SET

We appreciate the trust and confidence you have placed in 15WEST through the purchase of this bathroom vanity. We strive to continually create quality products designed to enhance your home. Visit us online to see our full line of products available for your home improvement needs. Thank you for choosing 15WEST!

24MAY21