

TEWEST

BATH COLLECTION



Tiempo Estimado de Instalación Estimated Installation Time























Son necesarias 24 horas para completar el proceso de instalación.
Twenty-four hours is needed to complete the installation process.





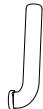



Número de Personas Requeridas Number of People Required

Dos personas son recomendadas para completar el proceso de instalación.
Two people are recommended to complete the installation process.

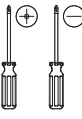
LISTA DE PIEZAS / LIST OF PARTS

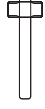
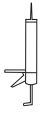
 A (1PC)	 B (1PC)	 C (1PC)	 D (2PC)	 E (1PC)	 F (1PC)	 G (1PC)	 H (1PC)	 I (2PC)	 J (2PC)	 K (2PC)	 L (2PC)
 M (2PC)	 N (1PC)	 O (1PC)	 P (1PC)	 Q (1PC)	 R (1PC)	 S (1PC)	 T (1PC)	 U (1PC)	 V (2PC)	 W (2PC)	

HERRAMIENTAS REQUERIDAS (NO INCLUIDAS) / TOOLS REQUIRED (NOT INCLUDED)

 Destornillador Phillips Phillips screwdriver	 Taladro eléctrico Electric drill	 Mazo suave Soft mallet	 Sellador Sealant	 Lápiz Pencil	 Nivelador Level	 Cinta métrica Measuring tape	 Martillo Hammer
--	--	--	--	--	---	--	---

CONTENIDO DEL PAQUETE / PACKAGE CONTENTS

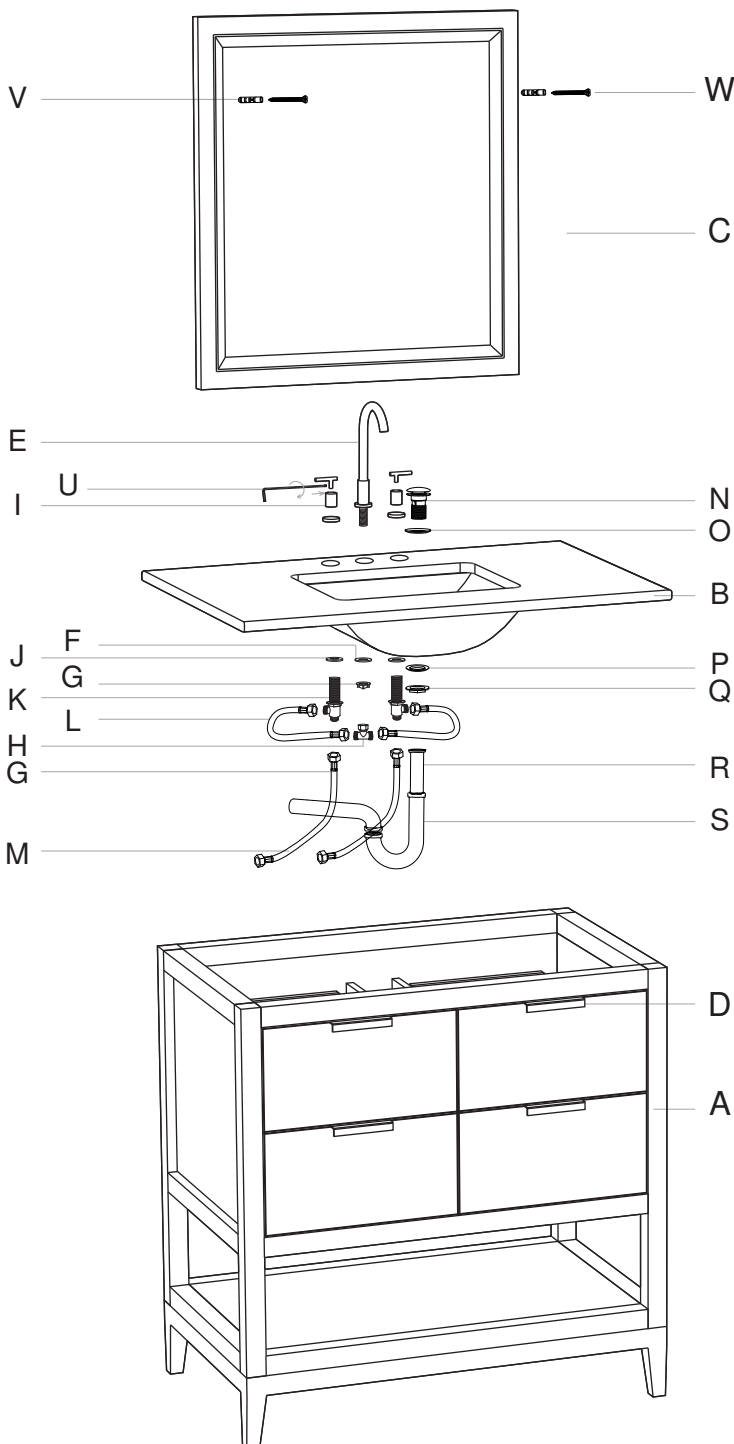

INSTALACIÓN / INSTALLATION

1 Instalación de la Manijas Installing the Handles

Por motivos de envío, las manijas (D) están preinstaladas por dentro de los cajones. Desinstalar las manijas (D). Vuelva a colocar las manijas (D) por el frente de los cajones usando los tornillos.

For shipping purposes, the handle (D) are pre-installed on the inside of the drawers. Un-install the handles (D). Re-attach the handles (D) onto the front of the drawers using handle screw.

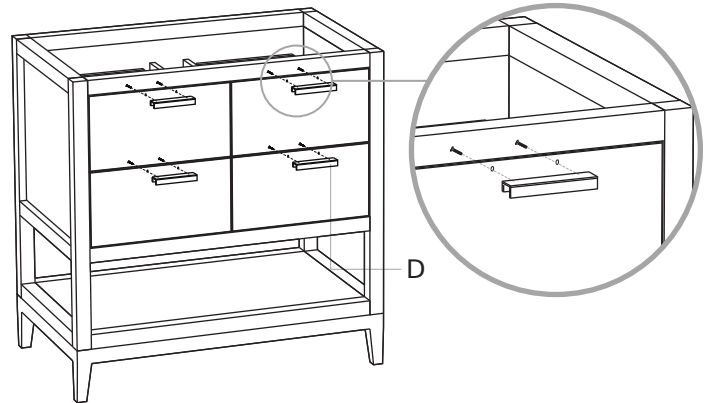

2 Instalación de la Placa y Lavabo Installing the Top and Basin

According to the sealant manufacturer's recommendations, apply sealant to the top edge of the cabinet, do not over apply. Gently place the countertop with basin (B) onto the cabinet (A). Then apply sealant to the top back edge of the countertop with basin (B) and wall. Allow to dry for 24 hours for proper curing.

Según las recomendaciones del fabricante del sellador, aplique el sellador a los bordes superiores del gabinete, no vuelva a hacer se aplican. Suavemente coloque la contracumbre con la palangana (B) en el gabinete (A). Entonces aplique el sellador a la cumbre atrás el borde de la contracumbre con la palangana (B) en el gabinete (A). Entonces aplique el sellador al borde superior de la contracumbre con la palangana (B) y pared. Permita secar durante 24 horas para la curación apropiada.

